

User's guide

COIL WINDING MACHINE



ERN 52



TPC s.r.o.
Pálenica 53/79
033 01 Liptovský Hrádok
SLOVAKIA
Tel.: +421-44-5221633
Fax: +421-44-5222088
E-mail: tpc@tpc.sk

COIL WINDING MACHINE ERN 52

USER´S GUIDE

Contents:

1. Introduction
2. Machine description
3. Description of controls
4. Setting up and operating
5. Programming
6. Gear change
7. Serial interface
8. Completeness and enclosure
9. Fuse change
10. Maintenance
11. Warranty period and service
12. Appendices

1. INTRODUCTION

Bench-type universal coil winding machine ERN 52 is designed for winding the coils, transformers, chokes, resistors, etc with wire up to \varnothing 5,0 mm.

Features:

- wide range of application for winding simple or complicated coils, multichamber coils, trapezoidal or asymmetric windings
- the spindle is driven by a AC servo drive with a rareearth-based motor
- pitch control unit on ball bearings with a separate stepping motor and micro-stepping
- accurate reversible counting of turns and positioning of the spindle
- microprocessor-controlled winding cycle increases productivity
- serial interface RS 232

Technical data:

Wire diameter:	0,02 - 5,0 mm
Pitch range:	0,02 - 10,0 mm/rev.
Winding width:	0,10 - 450 mm
Winding speed / Torque:	0 - 4000 rpm / 3,5 Nm 0 - 1000 rpm / 15 Nm 0 - 500 rpm / 30 Nm
Accuracy of spindle stop:	0,01 turn
Spindle position pre-set:	by 0,1 of a turn
Max. speed of wire guide:	shift max. 100 mm/s winding max. 75 mm/s
Acceleration/deceleration:	see Tab.
Max. coil diameter:	450 mm
Distance between centers:	650 mm
Dimensions:	1235 x 530 mm
Weight:	cca 180 kg
Power supply:	3 x 400 V / 50...60 Hz
Power consumption:	max. 1,5 kVA
Noise:	max. 74 dB

2. MACHINE DESCRIPTION

Coil winding machine consists of the following parts:

- **Control unit** containing control electronics and programming elements
- **Drive unit** containing servomotor with gears, pitch control unit with stepping motor, power electronics and control elements
- **Base plate**
- **Protection shield**
- **Stand** with spool holders and dereelers (optional accessories)
- **Tailstock** (optional)
- **Wire guides** (optional)

The machine contains a minimum number of mechanical parts as the coordination between spindle rotation and wire guide speed is controlled electronically with a separate stepping motor.

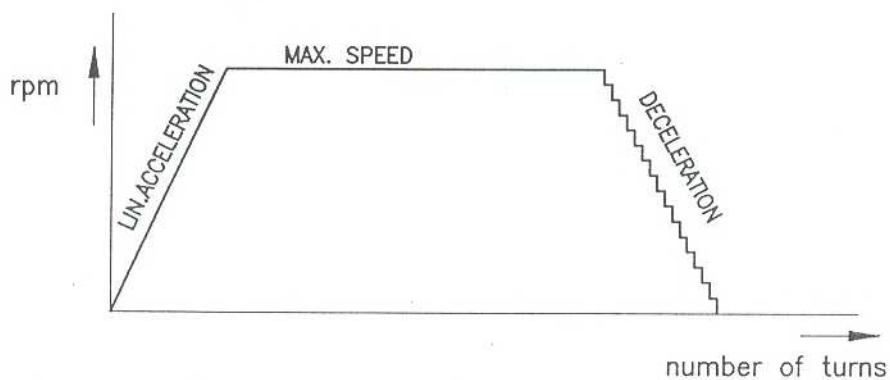

Deceleration is microprocessor-controlled, which ensures an accurate stopping and positioning of the spindle at minimum winding time.

3. DESCRIPTION OF CONTROLS

- 1 - POWER ON/OFF switch
- 2 - EMERGENCY STOP - disconnects power in emergency
- 3 - POWER ON indicator
- 4 - START button - starts winding cycle
- 5 - STOP button - breaks winding cycle
- 6 - BRAKE OFF - switches off the electromagnetic brake
- 7 - DISPLAY
- 8 - KEYBOARD with functions and numbers
- 9 - ENTER - enters data to the memory
- 10 - RESET - sets the initial stage
- 11 - CODE TABLE - choose the code of the wire diameter according to this table when you program the machine
- 12 - PROGRAM BLOCK KEY
- 13 - Connector for a serial interface RS 232
- 14 - Timing gear cover
- 15 - Gear switch
- 16 - Connector for multifunction footswitch
- 17 - Fixing screws
- 18 - Auxiliary output
- 19 - MAIN SWITCH - plug
- 20 - Main a.c. circuit breaker

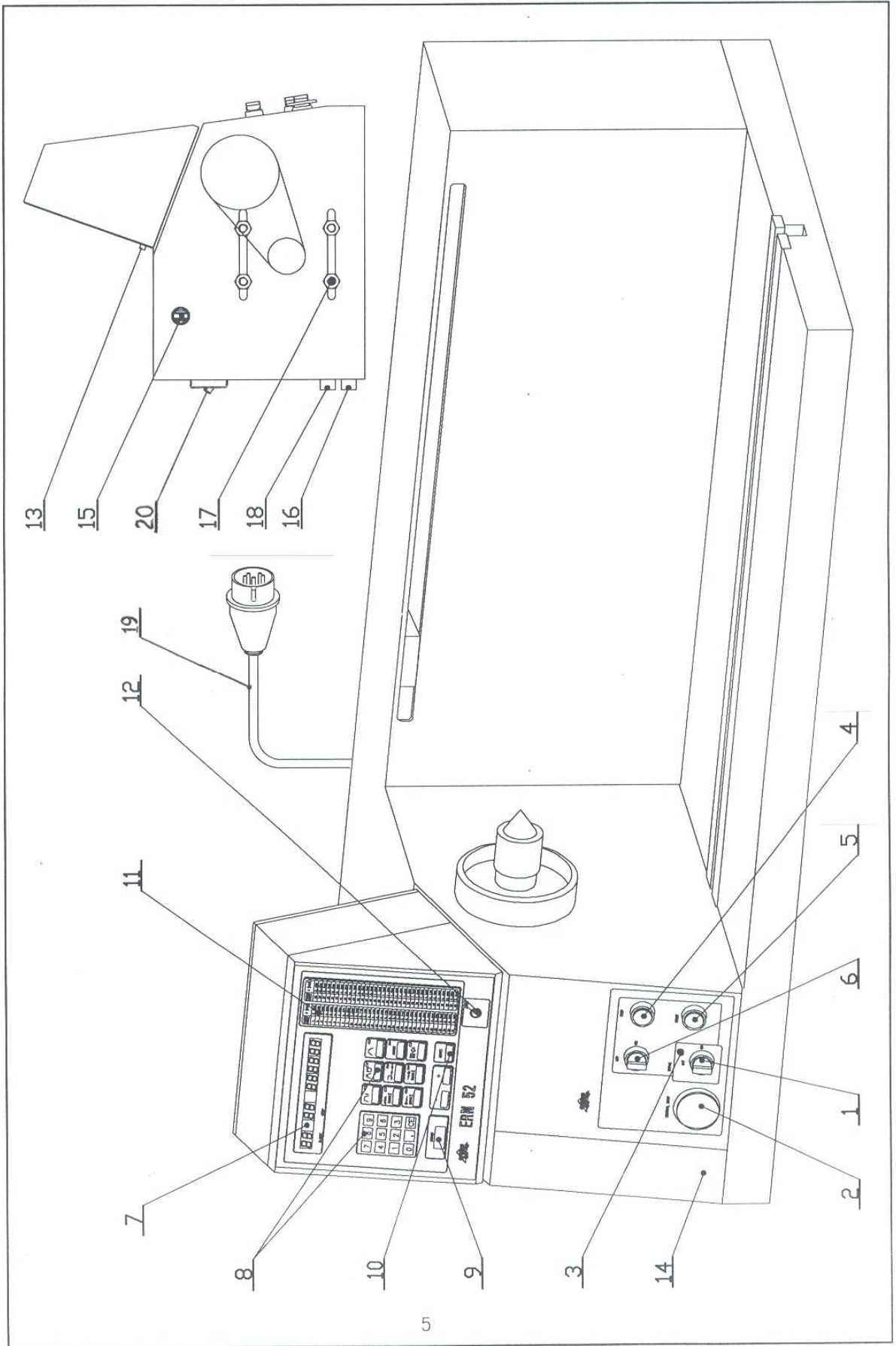

4. SETTING UP AND OPERATING

The machine is delivered partly disassembled for easier packing and transport. Before you switch the machine on for the first time, assemble it as follows:

- a) Fasten the control unit on the drive unit. Connect the main power plug and the 25-pin connector on the back panel of the control box.
- b) Check and fasten the fuse cartridges on the back panel of the drive unit.
- c) Assemble the stand with spool holders and dereelers.
- d) Connect the multifunction footswitch to the socket (16) on the back panel (lower).

The machine is assembled and prepared to use.

Switch the machine on by the POWER ON switch. After pressing the ENTER button the machine is automatically reset to the initial stage (step „00“). The control system sets the last programmed block. The wire guide moves to initial (reference) position. All this means that after switching the machine ON and pressing the ENTER, it is ready to work.

Pressing the START button starts the winding cycle. You can break the winding cycle by the STOP button.

FOLLOWING CORRECTIONS CAN BE MADE FOR WINDING PROCESS:

A) Spindle reference position setting

The spindle can be positioned within +- few degrees and the precise position is kept for any amount of windings.

You can set the spindle reference position as follows:

- switch the brake-off by the switch (6)
- turn the spindle manually to the desired position and return the switch (6) to the former position.
- Press RESET
- Press ENTER

Note: When you switch the machine ON (by MAIN SWITCH POWER or EMERGENCY STOP button), RESET is realised automatically and the position of the spindle is taken as reference position.

B) Wire guide relative position

Relativ position enables to change all the coordinates already set in the block in range 0 - 209 mm by steps 0,1 mm. This means that the value of relative position is added from every coordinate in the block.



Holding the buttons or pressed (cca 0,5 s) moves the wire guide continuously.

C) Pitch correction (Key (12) in position)

Press You can make correction of pitch by or (max.+ - 9)

so that the pitch is corresponding to the wire diameter exactly.

When you program a new wire diameter code, the correction is automatically set to „0“

D) Left and right reversal point correction (Key (12) in position)

Press or You can set the left or right reversal point of the wire guide by or with accuracy 0,1 mm.

E) Number of turns correction (Key (12) in position)

After pressing this button - - - - - is displayed and you can enter (change)

a new number of turns manually.

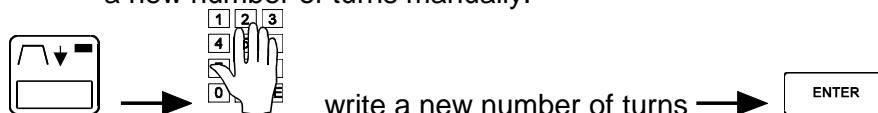

F) Pitch for the code „99“ (Key (12) in position )



After pressing this button, the PITCH value valid for the code „99“ is programmed. „ - „ is always displayed on the right.

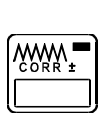

write the code and correction according to the table (range 0-96)





The programmed value is valid for all the steps (windings) where in the key position WITHOUT MARKING, the value „99“ was entered. This means, that re-programming of this value can change the PITCH and correction.

G) Correction of the wire guide position (Key (12) in position )



After pressing this button, the current position of the wire guide is displayed.

Buttons  and  can adjust the wire guide position by steps of 0,1 mm.

Holding the buttons  or  pressed (cca 0,5 s) moves the wire guide continuously.

After finishing the correction, press  again.

H) Return to the beginning of the step (Key (12) in position )



Using this button you can return to the beginning of the step (winding).

For example, if the wire breaks during the winding, just press STOP and the coil winding machine stops.

Then press  → CE and the task is returned to the beginning of the step, including the wire guide position and number of turns.

I) Back winding (Key (12) in position )

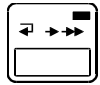

After pressing this button „bA“ is displayed and you can wind back by the pedal. Number of turns is subtracted and wire guide moves in opposite direction.

After finishing the back winding, press 

J) Pedal control speed (Key (12) in position )



Using this button you can set the top speed and the direction of rotation only for pedal control.

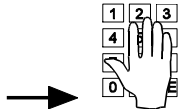

Enter the value 0 - 30 and direction (+/-) 

This speed and direction of rotation is then valid for all the processes controlled by the pedal.

NOTE: In case a pedal speed „0“ is programmed, max.speed, acceleration, deceleration will be taken from actual step.

K) Deceleration ramp for the STOP button (Key (12) in position )

This is deceleration ramp of the spindle after pressing the STOP button. The programmed value is valid for all blocks and modes.

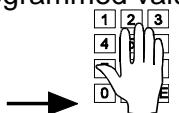

write value for the deceleration ramp (range 1 – 8) 

Value „ 1 „ the shortest dec. ramp

⋮

Value „ 8 „ the longest dec. ramp

5. PROGRAMMING

ENTERING THE DATA (GENERAL SCHEME)

PARAMETER → VALUE → ENTER

Note: You can not enter data in step „00“ - initial state, that follows after switching the machine on by POWER ON/OFF switch or after machine reset.

Use button or a numeric button to get to the desired winding (STEP).

CHOOSING THE BLOCK (Key (12) in position)



Note: Blocks 0 - 4 permit to program 99 steps (windings).
Blocks 5 - 9 permit to program 49 steps (windings).

CHOOSING THE STEP

To choose the proper winding, you can use either of the following methods:

a) keyboard: Winding number → ENTER

b) buttons or

PROGRAMMING WINDINGS PARAMETERS

A. WINDING (Key (12) in position)

1. Number of turns

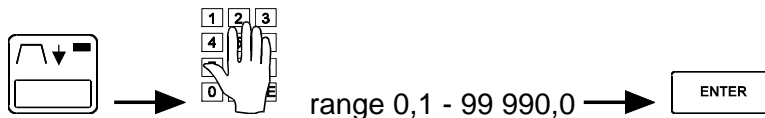

2. Max.speed and winding direction (Key (12) in position )

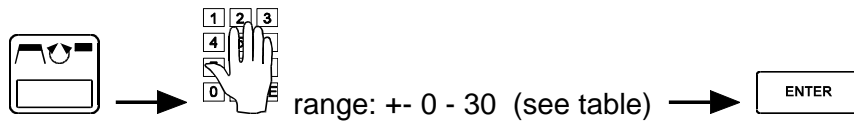

‘ + ‘ clockwise direction
 ‘ - ‘ anticlockwise direction

3. Acceleration and deceleration of the spindle (Key (12) in position )

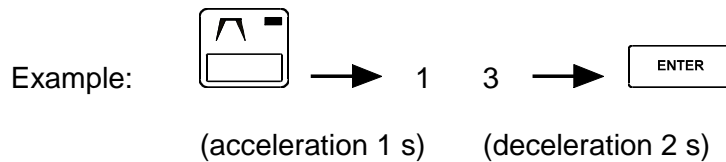
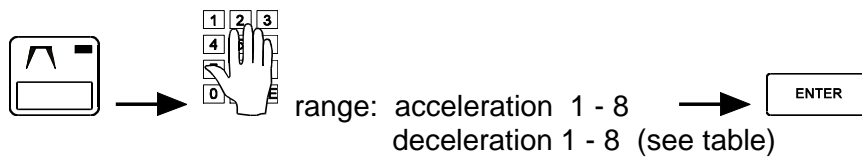

4. Pitch and correction (Key (12) in position )

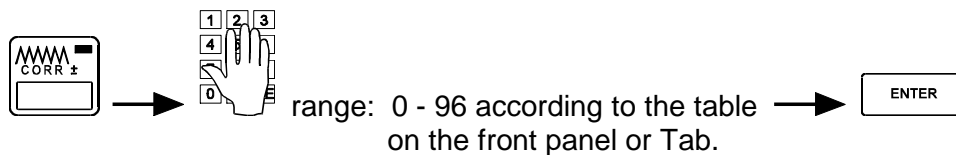

- correct the pitch within the range +- 9 by buttons  or  if necessary

5. Type of cycle (Key (12) in position )

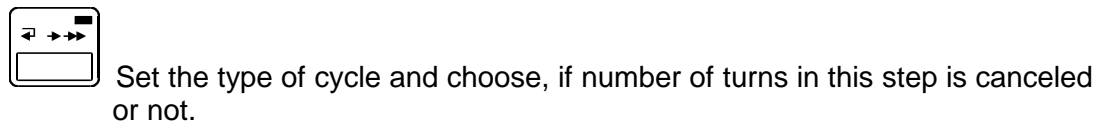

‘ 0X ‘ number of turns is set to zero (canceled)

‘ 1X ‘ number of turns is not canceled

where „X“ is the type of cycle (see appendix)

6. Left reversal point (Key (12) in position )

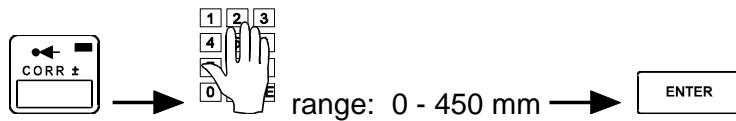

- correct by buttons or if necessary

7. Right reversal point (Key (12) in position )

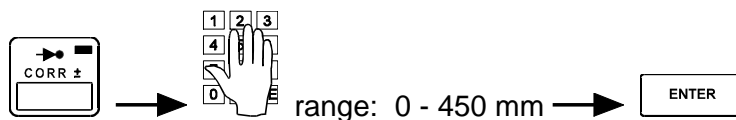

- correct by buttons or if necessary

If the wire guide occurs inside of the winding window (between left and right reversal point), its direction can be programmed as follows

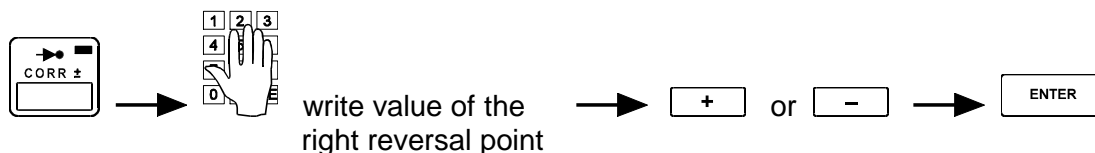

Left reversal
point

position of the
wire guide

right reversal
point

8. Auxiliary functions (Key (12) in position )



protection shield auxiliary output

Code 1: protection shield on, auxiliary output switch off
Code 2: protection shield off, auxiliary output switch on

Auxiliary connector (18):

Notice:

Power supply + 24 V DC -
max. load current 150 mA !

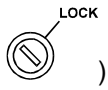
B. SHIFT (Key (12) in position )

If you enter „0“ to the number of turns, wire guide moves to the position of the right reversal point. In this case only the following parameters are programmed:

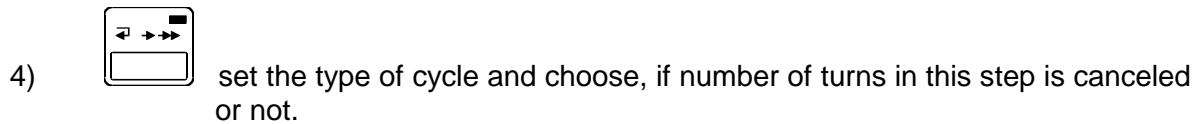
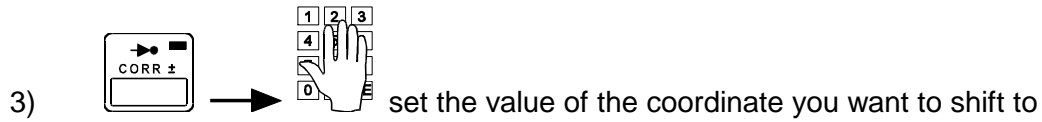
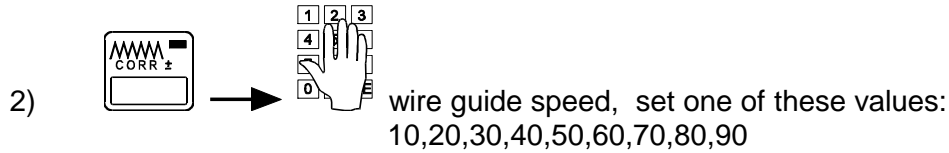

‘ 0X ‘ number of turns is set to zero (canceled)

‘ 1X ‘ number of turns is not canceled

where „X“ is the type of cycle (see appendix)

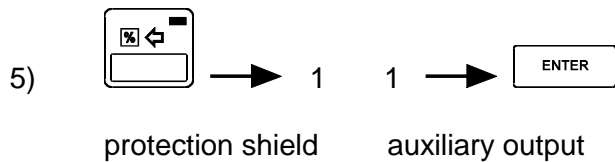

Code 1: protection shield on, auxiliary output switch off

Code 2: protection shield off, auxiliary output switch on

Other parameters are not important.

EXAMPLE 2: Number of turns: 0
 Pitch: : 0
 Right reversal point value: -5,2

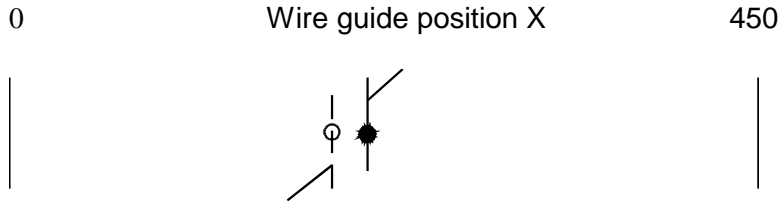

new position after jump: X - 5.2 mm

NOTE: When the minus value (e.g. -5,2 mm) is to be programmed, first write the value and then the minus sign.

ERROR CODES

Microprocessor control with powerful software enable wide range of programmable parameters. Mistakes in program are displayed by writing Error or Error code.

- ERROR 1** Mechanical displace of the wire guide.
 This code appears in case that the lateral power on the wire guide overcomes the torque of the step motor.
 Next procedure: press RESET
- ERROR 3** Protection shield is open.
 Next procedure: press ENTER and close the shield
- ERROR 4** Pitch or spindle speed is too high (exceeds the max.speed 75 mm/s of the wire guide).
 Next procedure: press ENTER and correct either spindle speed or pitch
- ERROR 5** Winding width is out of range.
 Next procedure: press ENTER and correct either relative position or reversal points
- ERROR 6** Program is not logic in the case type of cycle „3“, following step can not be the shift, jump or winding with the opposite speed direction.

6. GEAR CHANGE

Timing belt drive is under the cover (14). The machine is delivered with the gear „1000“.

CHANGING THE GEAR

- remove the cover (14), attached by 3 screws
- loosen four screws (17) and remove the timing belt

1. Changing to the gear „500“

- remove the timing gear signed „1000“ and put the one signed „500“ (delivered with the machine) instead
- use the longer timing belt, put on, tension and attach with the screws (17)
- turn the switch (15) to position „500“ rpm

2. Changing to the gear „4000“

- remove both timing gears. Put the gear with arim flange on the spindle shaft and gear „4000“ on the motor shaft. Put on the shorter narrower timing belt, tension it and attach with the screws (17)
- turn the switch (15) to position „4000“

Note:

After each gear change and turning the switch (15) is necessary to inform the control unit by pressing RESET or switching the machine OFF and ON.

7. SERIAL INTERFACE

The machine is equipped with a socket (13) for communication with a PC - interface RS 232.

Optional accessories offered by the producer comprise a connecting cable and a floppy disk with the program for creating the winding program on a PC.

Connector (13):

8. COMPLETENESS AND ENCLOSURE

Documents delivered with the machine:

1 pc certificate of quality and completeness

1 pc user's guide

ENCLOSURE:

2 pcs fuse T 630 mA/250V

1 pc microswitch WN 559 00

1 pc timing gear (100 teeth) TA 008 23

1 pc timing gear (32 teeth) TA 008 25

1 pc timing belt 046-040

1 pc timing belt 042-019

3 pcs allen key No 4,5,6

1 pc spanner No 36

1 pc spanner No 41

9. FUSE CHANGE

Change the wrong fuses at the POWER switch OFF and the main power plug disconnected. The fuses are on the back panel of the drive box. Be sure to use only the types of fuses specified by the producer.

10. MAINTENANCE

As the machine contains a minimum number of mechanical gears, the maintenance is simple. To ensure trouble-free work, following operations are recommended:

- clean regularly the winding space of dust, dirt and wire ends
- check tension of the timing belt
- the ball bearings have permanent grease filling, no lubrication is needed

11. WARRANTY PERIOD AND SERVICE

Warranty period is 12 months from the date of delivery.

Warranty and after warranty repairs are provided by TPC s.r.o. Liptovský Hrádok

12. APPENDICES

1. CODE TABLE OF SPINDLE SPEED
2. CODE TABLE OF ACCELERATION-DECELERATIONS TIMES
3. PITCH CODE TABLE
4. TYPE OF CYCLE
5. ELECTRIC DIAGRAMS
6. SPARE PARTS
7. EXAMPLE OF PROGRAMMING

CODE TABLE OF SPINDLE SPEED

CODE (0-30)	GEAR "500"	GEAR "1000"	GEAR "4000"
0	0	0	0
1	2	4	20
2	4	8	35
3	6	12	50
4	8	16	70
5	12	25	100
6	16	30	130
7	20	40	170
8	25	50	200
9	32	60	250
10	38	75	300
11	42	85	350
12	47	95	400
13	52	105	450
14	62	125	500
15	73	145	600
16	83	165	700
17	93	185	800
18	105	210	900
19	135	270	1000
20	166	330	1300
21	200	400	1600
22	230	450	1800
23	260	520	2100
24	290	580	2300
25	325	650	2600
26	350	700	2800
27	385	770	3000
28	415	830	3300
29	460	910	3700
30	500	1000	4000

CODE TABLE OF ACCELERATION - DECELERATION TIMES

(Valid for all gears)

CODE	ACCEL.TIME TO MAX.SPEED (S)	DEC.TIME FROM MAX.SPEED (S)
1	1,5	1,5
2	2,3	2,3
3	3,0	3,0
4	4,5	4,5
5	6,0	6,0
6	9,0	9,0
7	12,0	12,0
8	16,0	16,0

PITCH CODE

CODE	WIRE (mm)	PITCH (rpm)	CODE	WIRE (mm)	PITCH (rpm)
1	0,020	0,025	49	1,000	1,075
2	0,025	0,031	50	1,060	1,155
3	0,320	0,040	51	1,120	1,215
4	0,040	0,050	52	1,180	1,275
5	0,050	0,062	53	1,250	1,345
6	0,056	0,069	54	1,320	1,415
7	0,063	0,078	55	1,400	1,495
8	0,071	0,088	56	1,500	1,595
9	0,080	0,088	57	1,600	1,695
10	0,090	0,110	58	1,700	1,800
11	0,100	0,121	59	1,800	1,900
12	0,112	0,134	60	1,900	2,000
13	0,125	0,150	61	2,000	2,100
14	0,132	0,157	62	2,120	2,250
15	0,140	0,166	63	2,240	2,380
16	0,150	0,176	64	2,360	2,500
17	0,160	0,187	65	2,500	2,650
18	0,170	0,200	66	2,650	2,800
19	0,180	0,210	67	2,800	2,950
20	0,190	0,220	68	3,000	3,150
21	0,200	0,230	69		3,250
22	0,212	0,244	70		3,500
23	0,224	0,256	71		3,750
24	0,236	0,270	72		4,000
25	0,250	0,285	73		4,250
26	0,256	0,300	74		4,500
27	0,280	0,316	75		4,750
28	0,300	0,335	76		5,000
29	0,315	0,355	77		5,250
30	0,335	0,377	78		5,500
31	0,355	0,396	79		5,750
32	0,375	0,417	80		6,000
33	0,400	0,446	81		6,250
34	0,425	0,473	82		6,500
35	0,450	0,496	83		6,750
36	0,476	0,521	84		7,000
37	0,500	0,548	85		7,250
38	0,530	0,590	86		7,500
39	0,560	0,620	87		7,750
40	0,600	0,660	88		8,000
41	0,630	0,690	89		8,250
42	0,670	0,725	90		8,500
43	0,710	0,775	91		8,750
44	0,750	0,825	92		9,000
45	0,800	0,875	93		9,250
46	0,850	0,925	94		9,500
47	0,900	0,975	95		9,750
48	0,950	1,025	96		10,000



TYPE OF CYCLE

